

Mais informações acesse:  
[WWW.DAROSMATRIZES.COM.BR](http://WWW.DAROSMATRIZES.COM.BR)

# Catálogo de **Produtos**

Componentes  
**para Instalação**  
de Persianas

GRUPO

**DAROS**

— DESDE 1988 —

# Presilhas

	<p>Presilha 50 mm Pintada Branco</p> <p><small>Códigos Perfis Alplex: 1720*, 5873,5318, 5295, 5204, 4534, 4297</small></p>	P50 P
	<p>Presilha 50 mm Zincada</p> <p><small>Códigos Perfis Alplex: 1720*, 5873,5318, 5295, 5204, 4534, 4297</small></p>	P50 Z
	<p>Presilha 40 mm Pintada Branco</p>	P40 P
	<p>Presilha 40 mm Zincada</p>	P40 Z
	<p>Presilha 40 mm Pintada Marrom, bege, cinza e preto.</p>	P40 PM P40 PBG P40 PC P40 PP
	<p>Presilha 50 mm Pintada Marrom, bege, cinza e preto.</p> <p><small>Códigos Perfis Alplex: 1720*, 5873,5318, 5295, 5204, 4534, 4297</small></p>	P50 PM P50 PBG P50 PC P50 PP
	<p>Presilha da Horizontal 50 Zincado</p>	PH 50 Z
	<p>Presilha da Horizontal 50 Branco</p>	PH 50 PB
	<p>Presilha da Horizontal 50 Marrom, bege, preto, cinza</p>	PH 50 PM PH 50 PBG PH 50 PP PH 50 PC
	<p>Presilha da Horizontal PH50 Monocomando Branco</p>	MPH50 PB
	<p>Presilha da Horizontal PH50 Monocomando Zincado</p>	MPH50 Z
	<p>Presilha da Horizontal 25 Zincada</p>	PH25 Z

	Presilha da Horizontal 25 Zincada Entre Vidros	PH 25 EV
	Freio da PH50	FPH 50
	Presilha 20mm Pintada Observação: Sem furo	P20 P
	Presilha 19mm Pintada Observação: Com furo	P19 P
	Presilha 29mm Pintada Observação: Com furo	P29 P
	Presilha 30mm Pintada Observação: Sem furo	P30 P
	Presilha 80mm Pintada	P80 P
	Presilha da Romana Zincada	PR Z
	Presilha da Romana Pintada	PR P
	Presilha da Romana Temperada Branca	PRT PB
	Presilha da Romana Temperada Marrom, bege, preto, cinza	PRT PM PRT PBG PRT PP PRT PC

	Presilha da Romana Temperada Zincada	PRT Z
	Nova Presilha da Romana Temperada Nas opções coloridas, branca e zincada.	

## Pesos

	Peso 20	206
	Peso 40	86
	Peso 50	321
	Peso de Celular 25	PC 25
	Peso de Celular 45	PC 45
	Peso Envelope 09	Peso 09
	Peso Envelope 11	Peso 11
	Peso Envelope Tira Vertical	Peso Tira V

# Suportes Verticais Sem Encaixe

	Suporte da Vertical 5x6 Sem encaixe p/ Bando Zincado	SV5X6 Z
	Suporte da Vertical 5x6 Sem encaixe p/ Bando Pintado	SV 5X6 P
	Suporte da Vertical 5x6 T Sem encaixe p/ Bando Zincado	SV 5X6 TZ
	Suporte da Vertical 5x6 T Sem encaixe p/ Bando Pintado	SV 5X6 TP
	Suporte da Vertical 5x8 Sem encaixe p/ Bando Zincado	SV 5X8 Z
	Suporte da Vertical 5x8 Sem encaixe p/ Bando Pintado	SV 5X8 P
	Suporte da Vertical 5x8 "T" Sem encaixe p/ Bando Zincado	SV 5X8 TZ
	Suporte da Vertical 5x8 "T" Sem encaixe p/ Bando Pintado	SV 5X8 TP
	Suporte da Vertical 5x11 Sem encaixe p/ Bando Zincado	SV 5x11 Z S/ Enc.
	Suporte da Vertical 5x11 Sem encaixe p/ Bando Pintado	SV 5x11 P S/ Enc.

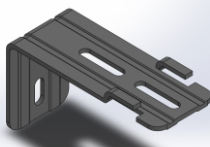
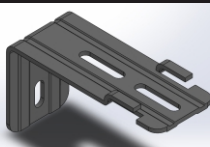
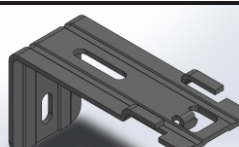
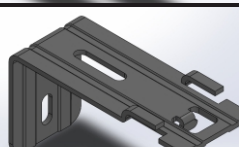

	Suporte da Vertical 5x11 "T" Sem encaixe p/ Bando Zincado	SV 5x11 TZ S/ Enc.
	Suporte da Vertical 5x11 "T" Sem encaixe p/ Bando Pintado	SV 5x11 TP S/ Enc.
	Suporte da Vertical 5x13 Sem encaixe p/ Bando Zincado	SV 5x13 Z S/ Enc.
	Suporte da Vertical 5x13 Sem encaixe p/ Bando Pintado	SV 5x13 P S/ Enc.
	Suporte da Vertical 5x13 "T" Sem encaixe p/ Bando Zincado	SV 5x13 TZ S/ Enc.
	Suporte da Vertical 5x13 "T" Sem encaixe p/ Bando Pintado	SV 5x13 TP S/ Enc.

## Suportes Verticais Com Encaixe

	Suporte da Vertical 5x8 Com encaixe p/ Bando Zincado	SV 5X8 Z C/ Enc.
	Suporte da Vertical 5x8 Com encaixe p/ Bando Pintado	SV 5X8 P C/ Enc.
	Suporte da Vertical 5x8 "T" Com encaixe p/ Bando Zincado	SV5X8 TZ C/ Enc.
	Suporte da Vertical 5x8 "T" Com encaixe p/ Bando Pintado	SV5X8 TP C/ Enc.

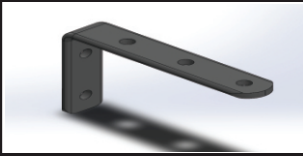
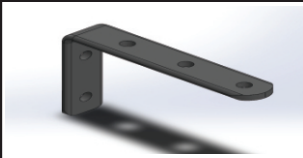
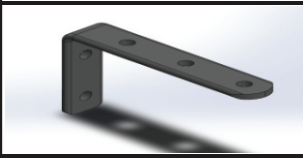
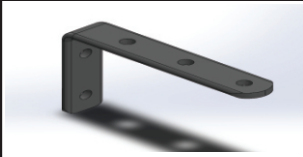
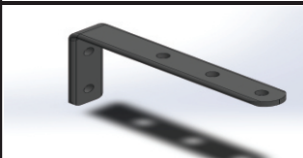

	Suporte da Vertical 5x11 Com encaixe p/ Bando Zincado	SV 5x11 Z
	Suporte da Vertical 5x11 Com encaixe p/ Bando Pintado	SV 5x11 P
	Suporte da Vertical 5x11 "T" Com encaixe p/ Bando Zincado	SV 5x11 TZ
	Suporte da Vertical 5x11 "T" Com encaixe p/ Bando Pintado	SV 5x11 TP
	Suporte da Vertical 5x13 Com encaixe p/ Bando Zincado	SV 5x13 Z
	Suporte da Vertical 5x13 Com encaixe p/ Bando Pintado	SV 5x13 P
	Suporte da Vertical 5x13 "T" Com encaixe p/ Bando Zincado	SV 5x13 TZ
	Suporte da Vertical 5x13 "T" Com encaixe p/ Bando Pintado	SV 5x13 TP
	Suporte da Vertical T Central Com encaixe p/ Bando Zincado	SV 5x13 TC Z
	Suporte da Vertical T Central Com encaixe p/ Bando Pintado	SV 5x13 TC P

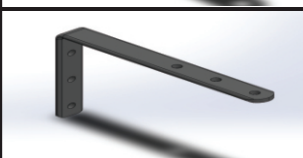
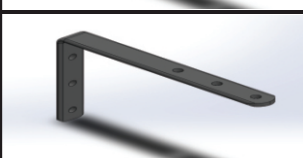
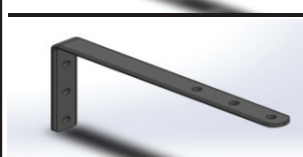
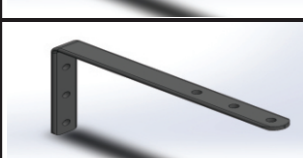
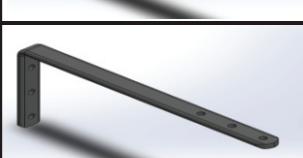
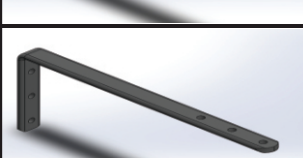
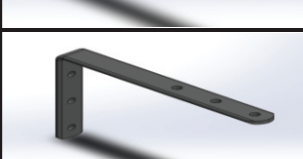
Suportes Verticais  
Finos

	Suporte da Vertical Fino 5x5 Zincado	SVF5X5 Z
	Suporte da Vertical Fino 5x5 Pintado	SVF5X5 P
	Suporte da Vertical Fino 5x8 Zincado	SVF 5X8 Z
	Suporte da Vertical Fino 5x8 Pintado	SVF 5X8 P
	Suporte da Vertical Fino 5x10 Zincado	SVF 5X10 Z
	Suporte da Vertical Fino 5x10 Pintado	SVF 5X10 P
	Suporte da Vertical Fino 8x13 Zincado	SVF 8X13 Z
	Suporte da Vertical Fino 8x13 Pintado	SVF 8X13 P
	Suporte da Vertical Fino 8x15 Zincado	SVF 8X15 Z
	Suporte da Vertical Fino 8x15 Pintado	SVF 8X15 P
	Suporte da Vertical Fino 8x20 Zincado	SVF 8X20 Z
	Suporte da Vertical Fino 8x20 Pintado	SVF 8X20 P
	Suporte da Vertical Fino 8x10 Pintado	SVF 8x10 P



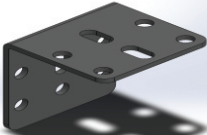
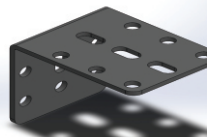
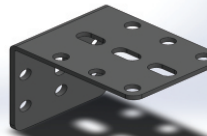





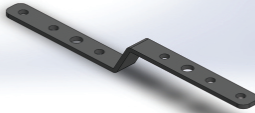
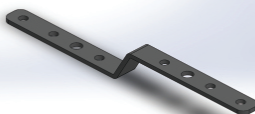

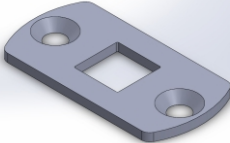
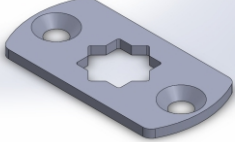
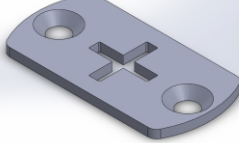
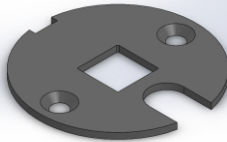
## Suportes Horizontais

	Suporte da Horizontal 5x3,5 Zincado	SH 5x3,5 Z
	Suporte da Horizontal 5x3,5 Pintado	SH 5x3,5 P
	Suporte da Horizontal 5x5 Zincado	SH 5x5 Z
	Suporte da Horizontal 5x5 Pintado	SH 5x5 P
	Suporte da Horizontal 5x7 Zincado	SH 5x7 Z
	Suporte da Horizontal 5x7 Pintado	SH 5x7 P
	Suporte da Horizontal 5x10 Zincado	SH 5x10 Z
	Suporte da Horizontal 5x10 Pintado	SH 5x10 P

## Outros Componentes

	Braço de Sobrepor Zincado	BS Z
	Braço de Sobrepor Branco	BS P

	Flange Motor 20 Quadrado Preto	F20Q PP
	Flange Motor 20 Estrela Preto	F20E PP
	Flange Motor 20 Cruzeta Preto	F20C PP
	Flange Motor 40 Quadrado Preto	F40Q PP
	Flange Motor 40 Estrela Preto	F40E PP
	Flange Motor 40 Cruzeta Preto	F40C PP
	Kit Adaptador Suporte Motor Cada Kit contém 1 Adaptador + 2 Parafusos	Kit Adapt.
	Suporte L para Motorização Zincado	SL Z
	Tensor 90	T 90
	Tensor Plano	TP
	Clip V Zincado	CV Z
	Clip Vertical Inclined	CV I





# Suportes Rolô





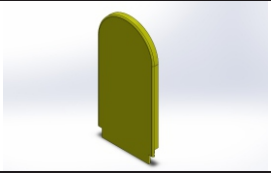

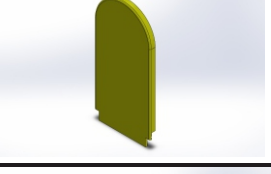
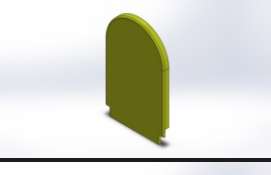
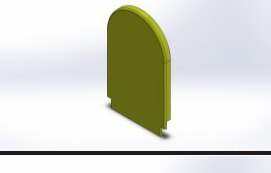

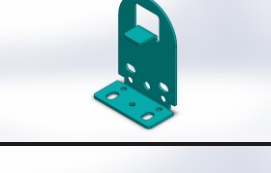
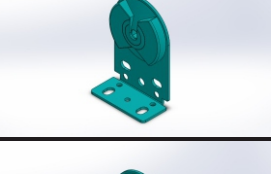
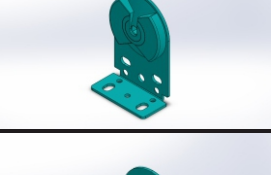
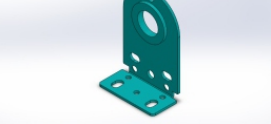

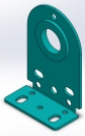

	Suporte Curto do Com. 38x40 Pintado	SCC 38x40 P
	Suporte Curto do Com. Intermediário 38x40 Pintado	SCCI 38x40 P
	Suporte Longo do Com. 38x54 Pintado	SLC 38x54 P
	Suporte Longo do Com. Intermediário 38x54 Pintado	SLCI 38x54 P
	Suporte Curto Bandô Móvel	SBM 42 P
	Suporte Longo Bandô Móvel Pintado	SBM 54 P
	Suporte Curto Bandô Móvel Intermediário Pintado	SBM I 42 P
	Suporte Longo Bandô Móvel Intermediário Pintado	SBM I 54 P

# Suportes Rolô

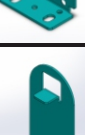
## Coloridos

	<p>Suporte Curto do Com. 38x40</p> <p>Bege, marrom, cinza e preto</p>	<p>SCC PBG SCC PM SCC PC SCC PP</p>
	<p>Suporte Curto do Com. Intermediário 38x40</p> <p>Bege, marrom, cinza e preto</p>	<p>SCC I PBG SCC I PM SCC I PC SCC I PP</p>
	<p>Suporte Longo do Com. 38x54</p> <p>Bege, marrom, cinza e preto</p>	<p>SLC PBG SLC PM SLC PC SLC PP</p>
	<p>Suporte Longo do Com. Intermediário 38x54</p> <p>Bege, marrom, cinza e preto</p>	<p>SLC I PBG SLC I PM SLC I PC SLC I PP</p>
	<p>Suporte Curto Bandô Móvel</p> <p>Bege, marrom, cinza e preto</p>	<p>SBM42 PBG SBM42 PM SBM42 PC SBM42 PP</p>
	<p>Suporte Longo Bandô Móvel</p> <p>Bege, marrom, cinza e preto</p>	<p>SBM54 PBG SBM54 PM SBM54 PC SBM54 PP</p>
	<p>Suporte Curto Bandô Móvel Intermediário</p> <p>Bege, marrom, cinza e preto</p>	<p>SBM42 I PBG SBM42 I PM SBM42 I PC SBM42 I PP</p>
	<p>Suporte Longo Bandô Móvel Intermediário</p> <p>Bege, marrom, cinza e preto</p>	<p>SBM54 I PBG SBM54 I PM SBM54 I PC SBM54 I PP</p>
	<p>Tampa Suporte Curto Branco</p>	<p>TSCC PB</p>
	<p>Tampa Suporte Curto</p> <p>Bege, marrom, cinza e preto</p>	<p>TSCC PBG TSCC PM TSCC PC TSCC PP</p>

	Tampa Suporte 55 Branco	TS55 PB
	Tampa Suporte 55 Bege, marrom, cinza e preto	TS55 PBG TS55 PM TS55 PC TS55 PP
	Tampa Suporte 65 Branco	TS65 PB
	Tampa Suporte 65 Bege, marrom, cinza e preto	TS65 PBG TS65 PM Ts65 PC TS65 PP
	Tampa Suporte 40 Branco	TS40 PB
	Tampa Suporte 40 Bege, marrom, cinza e preto	TS40 PBG TS40 PM TS40 PC TS40 PP
	Suporte Comando 40 Acmeda Branco	SC40A PB
	Suporte Comando 40 Acmeda Bege, marrom, cinza e preto	SC40A PBG SC40A PM SC40A PC SC40A PP
	Suporte Oposto 40 Acmeda Branco	SO40A PB
	Suporte Oposto 40 Acmeda Bege, marrom, cinza e preto	SO40A PBG SO40A PM SO40A PC SO40A PP
	Suporte Int. 40 Acmeda Branco Rolamento Ø15 e Ø17	SI40A PB

	<p><b>Suporte Int. 40 Acmeda</b>  Bege, marrom, cinza e preto  Rolamento Ø15 e Ø17</p>	SI40A PBG SI40A PM SI40A PC SI40A PP
	<p><b>Suporte Comando 55 Acmeda Branco</b></p>	SC55A PB
	<p><b>Suporte Comando 55 Acmeda</b>  Bege, marrom, cinza e preto</p>	SC55A PBG SC55A PM SC55A PC SC55A PP
	<p><b>Suporte Int. 55 Acmeda Branco</b>  Rolamento Ø15 e Ø17</p>	SI55A PB
	<p><b>Suporte Int. 55 Acmeda</b>  Bege, marrom, cinza e preto  Rolamento Ø15 e Ø17</p>	SI55A PBG SI55A PM SI55A PC SI55A PP
	<p><b>Suporte Oposto 55 Acmeda Branco</b></p>	SO55A PB
	<p><b>Suporte Oposto 55 Acmeda</b>  Bege, marrom, cinza e preto</p>	SO55A PBG SO55A PM SO55A PC SO55A PP
	<p><b>Suporte Comando 65 Acmeda Branco</b></p>	SC65A PB
	<p><b>Suporte Comando 65 Acmeda</b>  Bege, marrom, cinza e preto</p>	SC65A PBG SC65A PM SC65A PC SC65A PP
	<p><b>Suporte Int. 65 Acmeda Branco</b>  Rolamento Ø15 e Ø17</p>	SI65A PB
	<p><b>Suporte Int. 65 Acmeda</b>  Bege, marrom, cinza e preto  Rolamento Ø15 e Ø17</p>	SI65A PBG SI65A PM SI65A PC SI65A PP
	<p><b>Suporte Oposto 65 Acmeda Branco</b></p>	SO65A PB
	<p><b>Suporte Oposto 65 Acmeda</b>  Bege, marrom, cinza e preto</p>	SO65A PBG SO65A PM SO65A PC SO65A PP

# Suportes Reforçados

Novos

	Suporte Reforçado 56x55 Lingueta Branco	SRL5655PB
	Suporte Reforçado 56x55 Lingueta Preto	SRL5655PP
	Suporte Reforçado 56x55 Estrela Branco	SRE5655PB
	Suporte Reforçado 56x55 Estrela Preto	SRE5655PP
	Suporte Reforçado 56x55 Oposto Branco	SRO5655PB
	Suporte Reforçado 56x55 Oposto Preto	SRO5655PP
	Suporte Reforçado 56x55 Rolamento Branco	SRR5655PB
	Suporte Reforçado 56x55 Rolamento Preto	SRR5655PP
	Suporte Reforçado 56x75 Lingueta Branco	SRL5675PB
	Suporte Reforçado 56x75 Lingueta Preto	SRL5675PP
	Suporte Reforçado 56x75 Estrela Branco	SRE5675PB

	Suporte Reforçado 56x75 Estrela Preto	SRE5675PP
	Suporte Reforçado 56x75 Oposto Branco	SRO5675PB
	Suporte Reforçado 56x75 Oposto Preto	SRO5675PP
	Suporte Reforçado 56x75 Rolamento Branco	SRR5675PB
	Suporte Reforçado 56x75 Rolamento Preto	SRR5675PP
	Suporte Reforçado 85x75 Estrela Branco	SRE8575PB
	Suporte Reforçado 85x75 Estrela Preto	SRE8575PP
	Suporte Reforçado 85x75 Oposto Branco	SRO8575PB
	Suporte Reforçado 85x75 Oposto Preto	SRO8575PP
	Suporte Reforçado 85x75 Rolamento Branco	SRR8575PB
	Suporte Reforçado 85x75 Rolamento Preto	SRR8575PP



# Manual de Montagem P40

A presilha 40 (P40) aceita perfis com medidas entre 39mm a 40mm

As distâncias entre os componentes de instalação devem ser aproximadamente 50cm

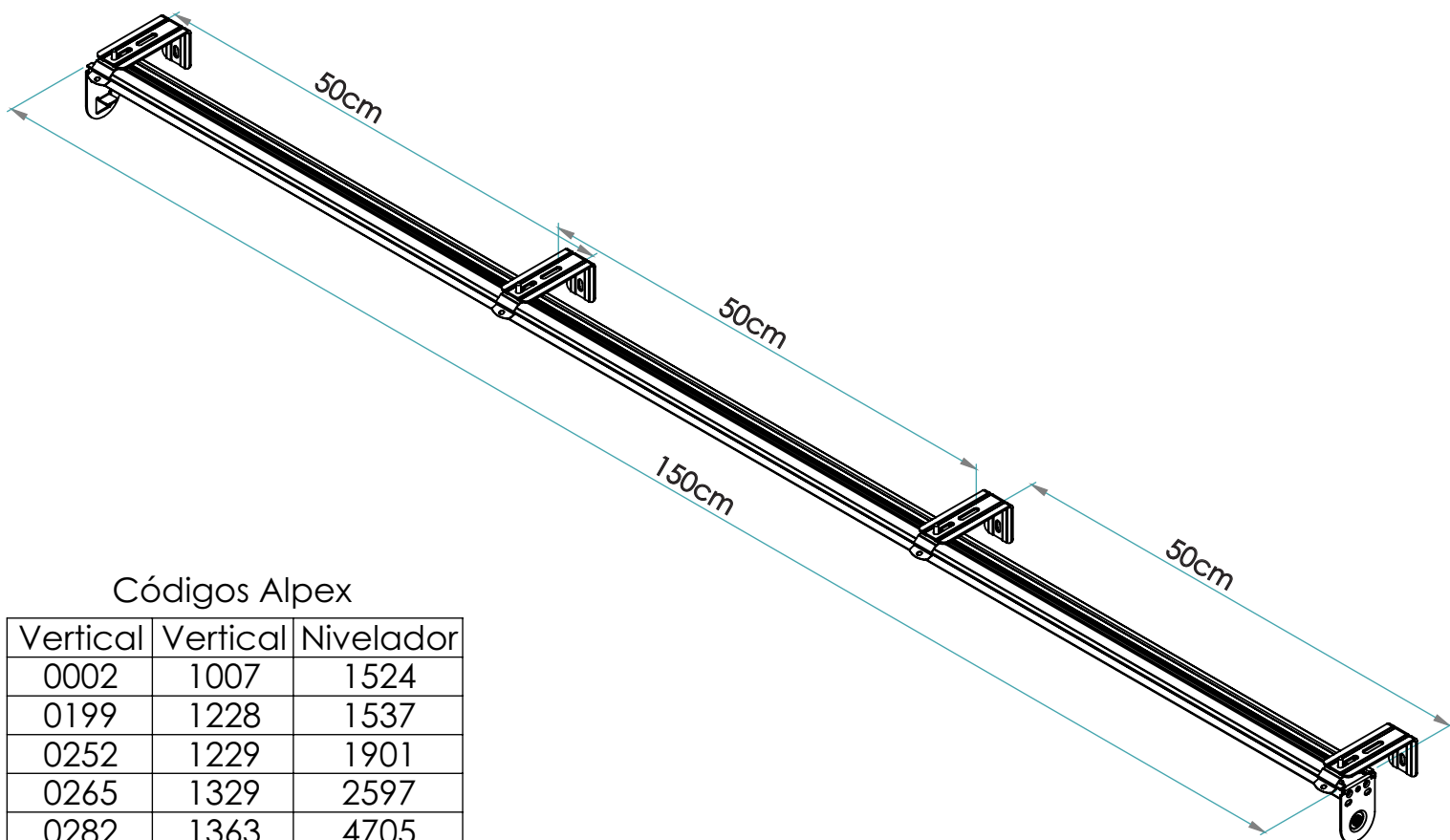

## Códigos Alpex

Vertical	Vertical	Nivelador
0002	1007	1524
0199	1228	1537
0252	1229	1901
0265	1329	2597
0282	1363	4705
0294	1406	5152
0306	1477	5864
0331	1478	
0357	1520	
0363	1669	
0365	1734	
0376	1840	
0502	2026	
0509	2061	
0765	2141	
0782	2270	
0833	2747	
0836	3936	
0867	4084	
0907	4413	
0994	5239	

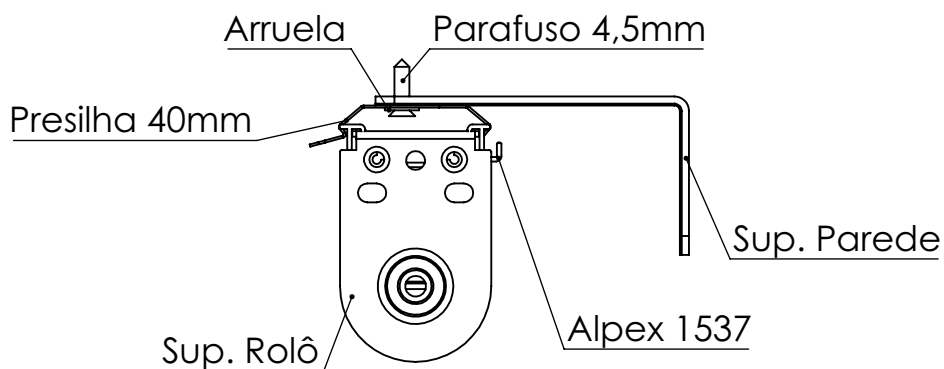

Componentes de instalação

# Manual de Montagem P50

A presilha 50 (P50) aceita perfis com medidas entre 48mm a 49mm

As distâncias entre os componentes de instalação devem ser aproximadamente 50cm

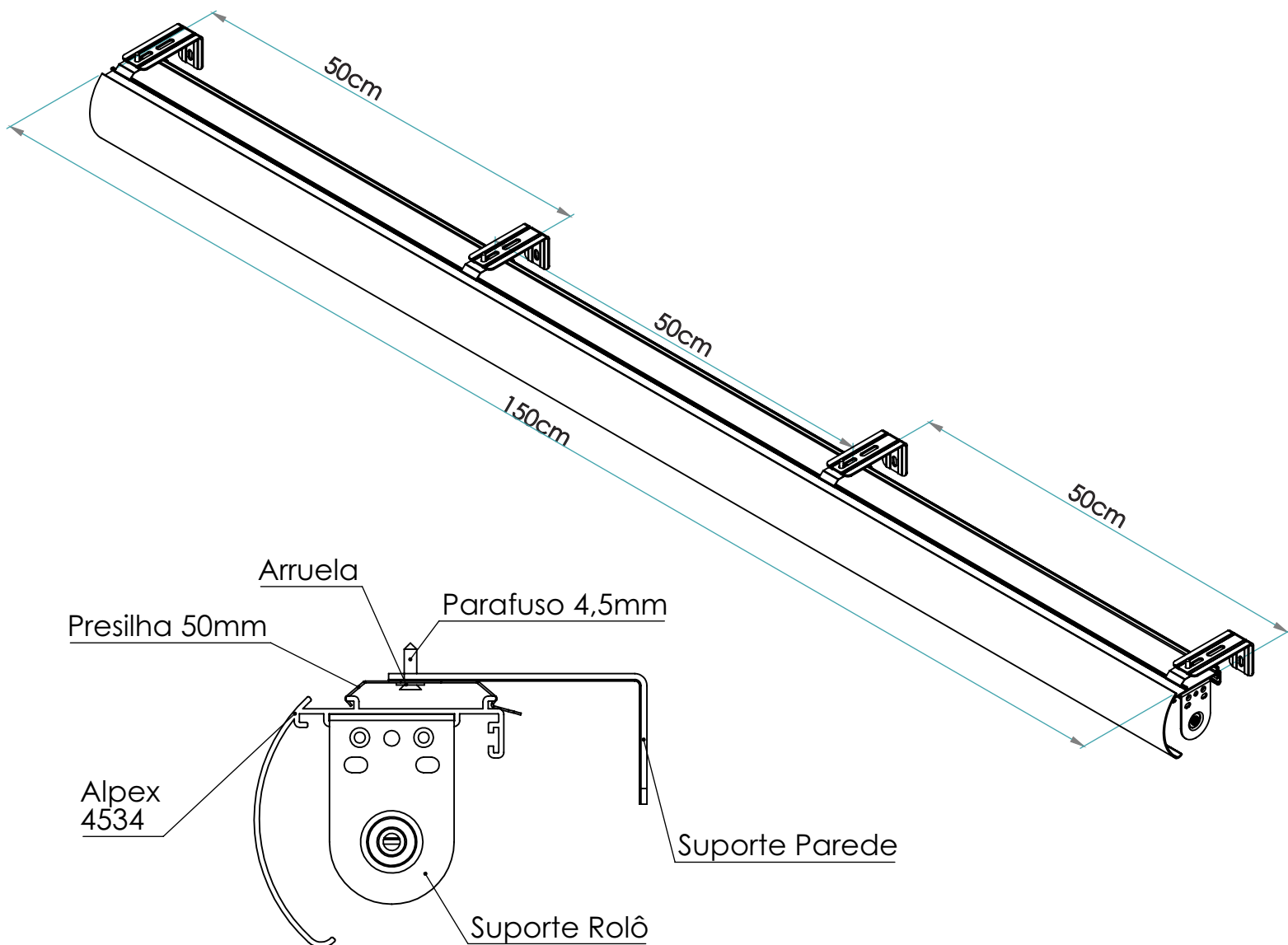

Componentes de Instalação

## Códigos Apex

Nivelador	Bando
1605	1720
2228	4297
5626	4534
5294	5295
	5873